

nulaxy®

# Wireless FM Transmitter

**NX16** User Manual

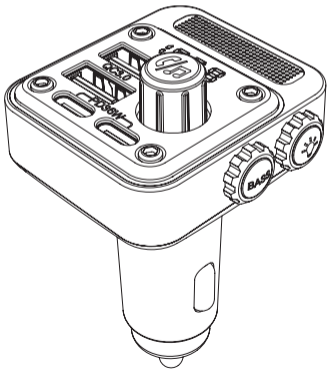

## Product Diagram

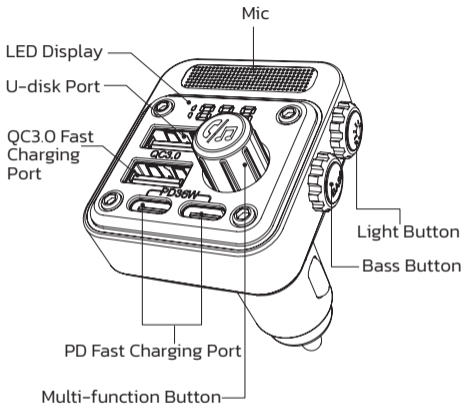

## Package Contents

- FM Transmitter x 1
- User Manual x 1

## Specifications

Bluetooth Version	5.3
FM Frequency	87.5MHz - 108.0MHz
Bluetooth Effective Distance	10 meters
QC3.0 Port Output	5V/3A, 9V/2A, 12V/1.5A
PD Port Output	5V/3A, 9V/3A, 12V/3A; PPS: 3.3V - 11V/3A
Input Voltage	12V - 24V
Maximum Output Power	54W
U-disk Capacity	Max 64 GB

## Installation

- 1) insert the FM transmitter into the car's cigarette lighter socket after starting your vehicle.

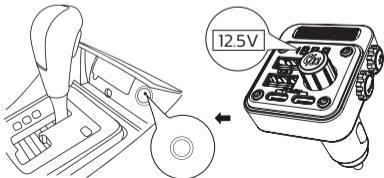

- Tip:** Please ensure the cigarette lighter socket is clean and rust-free before inserting the transmitter.
- 2) Upon insertion, the device will automatically power on, and the display will show "HI," the current voltage, and the Bluetooth frequency in a flashing sequence.

## Connection Setting

### Step 1: Pair the FM Transmitter with Your Car

- 1). Power on your car radio and tune it to an unused FM frequency.

**Tip:** What is an unused frequency?

An unused frequency is a channel with no active radio programs broadcasting on it, producing only a slight rustling or static noise through your car's speakers.

- 2). Set the FM transmitter to the same frequency as the car radio.

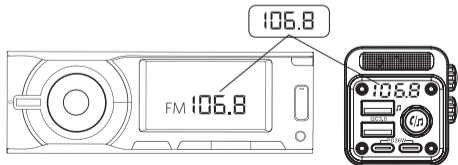

## Step 2: Pair the FM Transmitter with Your Smartphone

- 1). Enable Bluetooth on your smartphone, search for 'NX16', and select 'connect'.

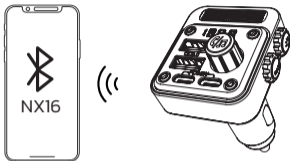

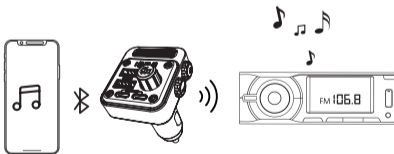

- 2). Once successfully connected, you can start playing music, using navigation, or enjoying hands-free calling through the device.





Note: Upon inserting a U-disk into the U-disk port, the device will automatically detect and play music files in MP3, WMA, FLAC, APE, or WAV format.

## Function Operation



### FM Frequency Adjustment

Switch frequency adjustment	Long press the "  " button until the frequency starts flashing.
Increase frequency	Rotate the "  " button clockwise.
Decrease frequency	Rotate the "  " button counterclockwise.



### Volume Adjustment

Increase volume	Rotate the "  " button clockwise.
Decrease volume	Rotate the "  " button counterclockwise.
A "drip, drip" prompt tone will indicate that the maximum volume has been reached.	

### Music Control

Pause/Play	Press the "  " button once.
Previous Track	Quickly rotate the "  " button counterclockwise.
Next Track	Quickly rotate the "  " button clockwise.



## Hands-free Calling

Answer/ Hang up a call	Press the "  " button once.
Reject a call	Long press the "  " button.
Redial last call	Quickly press the "  " button twice.

## U-disk / Bluetooth Switch

Switch between U-disk and Bluetooth mode	Quickly press the "  " button twice.
---	---

## RGB- Rainbow Ambient Light

Turn on/off light mode	Press the "  " button once.
Cycle through ambient lighting modes	Press the "  " button once.
Enter breathing light mode	Long press the "  " button.

## Bass Booster

Toggle bass function on/off:	Press the "  " button once.
---------------------------------	--

## Charge Your Device

The FM Transmitter is equipped with QC 3.0 and PD36W fast charging ports. You can charge your devices via these USB ports.

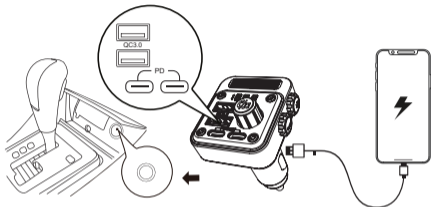

## Cautions

- 1 If the battery voltage drops below 11V, the voltage display will flash as an alarm to remind you to charge the car battery.
- 2 Avoid setting the car radio volume too high (typically 18 or lower) to prevent increased background noise.
- 3 Although this product has relatively strong transmission power, it is advisable to avoid frequencies with strong local signals to achieve better sound quality.
- 4 Do not use this product in environments that are dusty, humid, or have extremely high or low temperatures.



- 5 Avoid dropping the product to prevent surface damage or malfunction.
- 6 Do not disassemble the product without proper authorization, as doing so will void the warranty.

## **Trouble Shooting**

### **Device Malfunctioning**

1. Power is not responding, or display is not showing:
  - 1) Ensure the device is properly connected to the cigarette lighter port, and that the cigarette lighter is not significantly rusted.
  - 2) Unplug the device and try connecting it again.
  - 3) Check if the cigarette lighter port is receiving power normally.
2. Unable to play:
  - 1) Ensure that the USB device is properly connected to the player. Alternatively, try using another USB device.
  - 2) Confirm that the files on the USB device are supported by the product.
  - 3) Ensure that the volume is not set to 0.

### **Sound Troubles**

1. Noise is present, but there is no sound:

- 1) Confirm that the player is activated and not in pause mode.
  - 2) Check and adjust the volume settings on the car radio, FM transmitter, and the connected external device as needed.
2. The car audio is not receiving sound:
- 1) Ensure that the FM transmitter is turned on.
  - 2) Verify that the transmission frequency of the FM transmitter matches the reception frequency of the car's radio.
3. Poor transmission quality with noise:
- 1) Ensure no strong signal stations are broadcasting at the current transmission frequency.
  - 2) When in use, set your car radio to an unused frequency between 87.5–108.0 MHz (for the UK) or 88.1–107.9 MHz (for the US & Canada). Then, set the NX16 transmitter's frequency to match the car radio's.

## Warranty

The product comes with a 12-month hassle-free warranty.

If you encounter any issues, we are here to help. Should you find yourself unable to resolve the problem on your own, please do not hesitate to contact us for assistance.



Visit **[www.nulaxy.com](http://www.nulaxy.com)** for our 24/7 live chat or send an email to **[support@nulaxy.com](mailto:support@nulaxy.com)** for support.

## Produktdiagramm

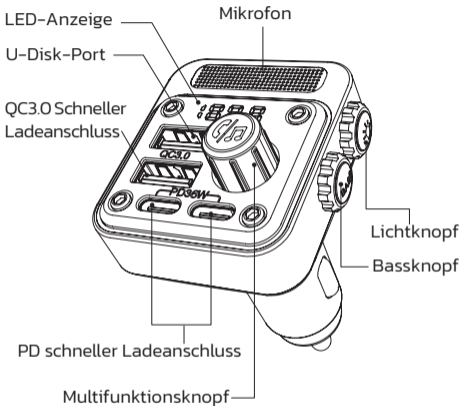

## Packungsinhalt

- FM -Sender x 1
- Benutzerhandbuch x 1

## Spezifikationen

Bluetooth -Version	5.3
FM Frequenz	87.0 MHz - 108.0 MHz
Bluetooth Effektiver Abstand	10 Meter
QC3.0 Portausgabe	5V/3A, 9V/2A, 12 V/1.5A
PD -Portausgabe	5V/3A, 9V/3A, 12V/3A; PPS: 3.3V - 11V/3A
Inputspannung	12V - 24V
Maximum Ausgangsleistung	54W
U-Disk-Kapazität	Max 64 GB

## Installation

- 1) Stecken Sie den FM -Sender nach dem Start Ihres Fahrzeugs in die Zigarette des Autos.

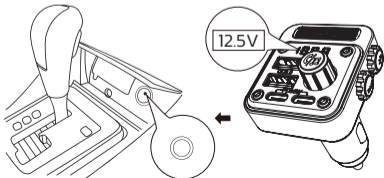

**Tipp:** Bitte stellen Sie sicher, dass die Zigarette leichtere Steckdose sauber und rostfrei ist, bevor der Sender einfügt.

- 2) Beim Einfügen wird das Gerät automatisch eingeschaltet, und das Display zeigt "Hi", die Stromspannung und die Bluetooth -Frequenz in einer Blitzsequenz.

## Verbindungseinstellung

**Schritt 1:** Kombinieren Sie den FM -Sender mit Ihrem Auto

- 1). Schalten Sie Ihr Auto -Radio an und stimmen Sie es auf eine nicht verwendete FM -Frequenz ein.

**Tipp:** Was ist eine ungenutzte Frequenz?

Eine ungenutzte Frequenz ist ein Kanal ohne aktive Radioprogramme, die nur zu einem leichten Rascheln oder statischen Geräuschen durch die Lautsprecher Ihres Autos erzeugt werden.

- 2). Stellen Sie den FM -Sender auf die gleiche Frequenz wie das Auto -Radio ein.

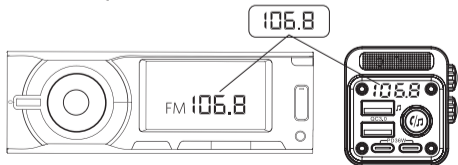

**Schritt 2:** Kombinieren Sie den FM-Sender mit Ihrem Smartphone

- 1). Aktivieren Sie Bluetooth auf Ihrem Smartphone, suchen Sie nach "NX16" und wählen Sie "Connect".

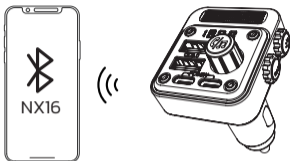

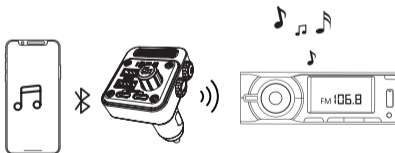

- 2). Sobald Sie erfolgreich miteinander verbunden sind, können Sie Musik spielen, Navigation verwenden oder Freisprechanrufe durch das Gerät genießen.





**HINWEIS:** Beim Einfügen einer U-Disk in den U-Disk-Port erkennt das Gerät automatisch Musikdateien in MP3-, WMA-, FLAC-, APE- oder WAV-Format.

## Funktionsbetrieb



### FM -Frequenzanpassung

Frequenzanpassung Schalten	Langes Drücken Sie die Taste "  ", bis die Frequenz blinkt.
Frequenz erhöhen	Drehen Sie die Taste "  im Uhrzeigersinn.
Abnahme der Frequenz	Drehen Sie den Taste "  gegen den Uhrzeigersinn.

### )) Volumenanpassung



Lautstärke erhöhen	Drehen Sie die Taste "  im Uhrzeigersinn.
Abnahmevolumen	Drehen Sie die Taste "  gegen den Uhrzeigersinn.
Ein sofortiger Ton "Tropfen, Tropfen" zeigt an, dass das maximale Volumen erreicht wurde.	

### Musikkontrolle

Pause/Spiel	Drücken Sie einmal die Taste "  ".
Vorheriger Track	Drehen Sie schnell die Taste "  gegen den Uhrzeigersinn.
Nächstes Track	Drehen Sie schnell die Taste "  im Uhrzeigersinn.





## Freisprechanruf

Antwort/Auflegen Sie einen Anruf	Drücken Sie einmal die Taste "  ".
Einen Anruf ablehnen	Lange drücken Sie die Taste "  ".
Letzter Anruf von Redial	Drücken Sie zweimal die Taste "  ".

## U-Disk / Bluetooth-Schalter

Wechseln Sie zwischen U-Disk- und Bluetooth-Modus	Drücken Sie schnell die Taste "  " zweimal.
---	--

## RGB- Regenbogen Umgebungslicht

Ein-/Aus -Lichtmodus ausschalten	Drücken Sie einmal die "  "-Taste.
Fahrrad durch Umgebungsbeleuchtungsmodi	Drücken Sie einmal die "  "-Taste.
Geben Sie den Atemmodus ein	Lange drücken Sie die Taste "  ".

## Bassverstärker

Bassfunktion ein-/ ausschalten	Drücken Sie einmal die Taste "  ".
--------------------------------	---

## Laden Sie Ihr Gerät auf

Der FM -Sender ist mit QC 3.0- und PD 3.0 -Schnellladeanschlüssen ausgestattet. Sie können Ihre Geräte über diese USB -Anschlüsse aufladen.

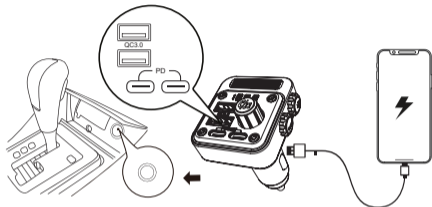

## Vorsichtsmaßnahmen

- 1 Wenn die Batteriespannung unter 11 V fällt, blinkt die Spannungsanzeige als Alarm, um Sie daran zu erinnern, die Autobatterie aufzuladen.
- 2 Vermeiden Sie es, das Auto -Funkvolumen zu hoch zu setzen (normalerweise 18 oder niedriger), um ein erhöhtes Hintergrundgeräusch zu verhindern.
- 3 Obwohl dieses Produkt eine relativ starke Übertragungsleistung aufweist, ist es ratsam, Frequenzen mit starken lokalen Signalen zu vermeiden, um eine bessere Klangqualität zu erzielen
- 4 Verwenden Sie dieses Produkt nicht in Umgebungen, die staubig, feucht sind oder extrem hohe oder niedrige Temperaturen aufweisen.

- 5 Vermeiden Sie es, das Produkt fallen zu lassen, um Oberflächenschäden oder Fehlfunktionen zu verhindern.
- 6 Zerlegen Sie das Produkt nicht ohne ordnungsgemäße Genehmigung, da dies die Garantie ungültig macht.

## **Fehlerbehebung**

### **Dysfonctionnement de l'appareil**

1. Die Stromversorgung reagiert nicht oder wird nicht angezeigt:
  - 1) Stellen Sie sicher, dass das Gerät ordnungsgemäß mit dem Zigarettenhellershafen verbunden ist und dass das Zigaretten –Feuerzeug nicht wesentlich verrostet ist.
  - 2) Ziehen Sie das Gerät aus und versuchen Sie es erneut, es anzuschließen.
  - 3) Überprüfen Sie, ob der Zigarettenheller normal Strom erhält.
2. Nicht spielen:
  - 1) Stellen Sie sicher, dass das USB –Gerät ordnungsgemäß mit dem Player verbunden ist. Versuchen Sie alternativ, ein anderes USB –Gerät zu verwenden.
  - 2) Bestätigen Sie, dass die Dateien auf dem USB –Gerät vom Produkt unterstützt werden.
  - 3) Stellen Sie sicher, dass das Volumen nicht auf 0 gesetzt ist.

## **Klangprobleme**

1. Lärm ist vorhanden, aber es gibt keinen Ton:

- 1) Bestätigen Sie, dass der Spieler aktiviert ist und nicht im Pause -Modus.
- 2) Überprüfen und passen Sie die Lautstärkereinstellungen auf dem Auto -Funk, dem FM -Sender und dem angeschlossenen externen Gerät nach Bedarf an.

2. Schlechte Übertragungsqualität mit Lärm:

- 1) Stellen Sie sicher, dass der FM -Sender eingeschaltet ist.
- 2) Stellen Sie sicher, dass die Übertragungsfrequenz des FM -Senders mit der Empfangsfrequenz des Radios des Autos übereinstimmt.

3. Schlechte Übertragungsqualität mit Lärm:

- 1) Stellen Sie sicher, dass bei der Stromübertragungsfrequenz keine starken Signalstationen übertragen werden.
- 2) Stellen Sie Ihr Auto-Radio beim Gebrauch auf eine nicht verwendete Frequenz zwischen 87,5-108,0 MHz (für Großbritannien) oder 88,1-107,9 MHz (für die USA & Kanada) ein. Stellen Sie dann die Frequenz des NX16 -Senders so ein, dass sie den des Automobils entsprechen.

## Garantie

Das Produkt verfügt über eine 12-monatige mühsame Garantie.

Wenn Sie auf Probleme stoßen, sind wir hier, um zu helfen. Wenn Sie das Problem nicht selbst lösen können, zögern Sie bitte nicht, uns zu kontaktieren, um Hilfe zu erhalten.



Visit **[www.nulaxy.com](http://www.nulaxy.com)** for our 24/7 live chat or send an email to **[support@nulaxy.com](mailto:support@nulaxy.com)** for support.

## Schéma de Produit

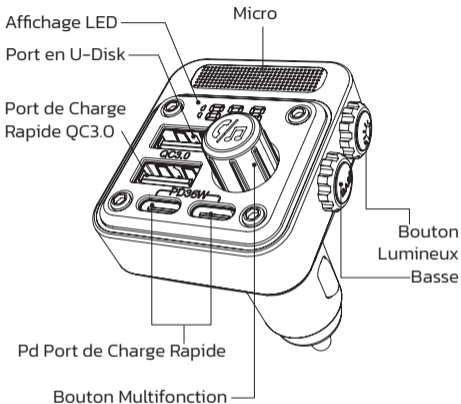

## Contenu du colis

Émetteur FM x 1  
Manuel d'utilisation x 1

## Caractéristiques

Bluetooth Version	5.3
FM Fréquence	87.0 MHz - 108.0 MHz
Bluetooth Distance Effective	10 mètres
QC3.0 Sortie du port	5V/3A, 9V/2A, 12V/1.5A
PD PORT Sortie	5V/3A, 9V/3A, 12V/3A; PPS: 3.3V - 11V/3A
Tension à Entrée	12V - 24V
Puissance de Sortie de Maximum	54W
Capacité à Sisque	Max 64 GB

## Installation

- 1) Insérez l'émetteur FM dans la prise en charge de la cigarette de la voiture après avoir commencé votre véhicule.

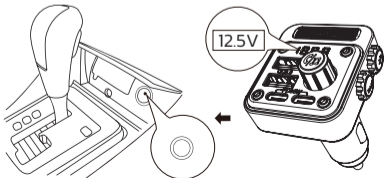

**CONSEIL:** Veuillez vous assurer que la prise légère cigarette est propre et sans rouille avant d'insérer l'émetteur.

- 2) Lors de l'insertion, l'appareil s'allume automatiquement et l'affichage affichera "Hi", la tension actuelle et la fréquence Bluetooth dans une séquence clignotante.

## Paramètre de connexion

**Étape 1:** Associez l'émetteur FM à votre voiture

- 1). Alimentation sur votre autoradio et réglez-la sur une fréquence FM inutilisée.

**Astuce:** Qu'est-ce qu'une fréquence inutilisée?

Une fréquence inutilisée est un canal sans émissions radio actives diffusées dessus, ne produisant qu'un léger bruissement ou un bruit statique à travers les haut-parleurs de votre voiture.

- 2). Réglez l'émetteur FM sur la même fréquence que l'autoradio.

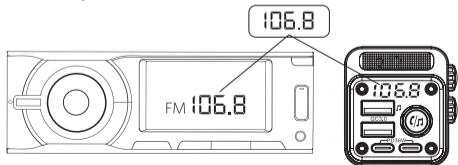



**Étape 2:** Associez l'émetteur FM à votre smartphone

- 1). Activez Bluetooth sur votre smartphone, recherchez «NX16» et sélectionnez «connecter».

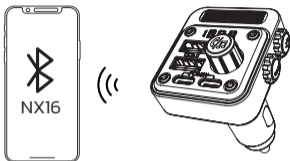

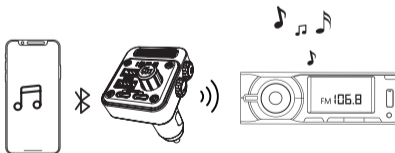

- 2). Une fois connecté avec succès, vous pouvez commencer à jouer de la musique, en utilisant la navigation ou en profitant d'appels mains libres via l'appareil.





**Remarque:** En insérant un disque U dans le port en U-Disk, l'appareil détectera et jouera automatiquement des fichiers musicaux au format MP3, WMA, FLAC, APE ou WAV.

## Opération de Fonction



### Réglage de la Fréquence FM

Réglage de la fréquence du commutateur	Appuyez sur le bouton "  " jusqu'à ce que la fréquence commence à clignoter.
Augmentez la fréquence	faites pivoter le bouton "  " dans le sens horaire.
Diminuez la fréquence	faites pivoter le bouton "  " dans le sens antihoraire.



### Réglage du Volume

Augmentez le volume	faites pivoter le bouton "  " dans le sens horaire.
Diminuez le volume	faites pivoter le bouton "  " dans le sens antihoraire.
Une tonalité "goutte à goutte, goutte à goutte" indiquera que le volume maximum a été atteint.	

### Contrôle de la Musique

Pause / play	appuyez une fois sur le bouton "  ".
Piste précédente	Faites rapidement pivoter le bouton "  " dans le sens antihoraire.
Piste suivante	Faites rapidement tourner le bouton "  " dans le sens horaire.



## Appel mains Libres

Répondez / accrochez un appel	appuyez une fois sur le bouton "  ".
Rejeter un appel	Appuyez sur le bouton "  ".
Redial Last Call	Appuyez rapidement deux fois sur le bouton "  ".

## Interrupteur U-Disk / Bluetooth

Communiquez entre le mode U-Disk et Bluetooth	appuyez rapidement deux fois sur le bouton "  ".
---	---

## RGB- Lumière Ambiante Arc-en-ciel

Allumez / désactiver le mode d'éclairage	appuyez une fois sur le bouton "  ".
Cycle à travers les modes d'éclairage ambiant	appuyez une fois sur le bouton "  ".
Entrez le mode de respiration	appuyez sur le bouton "  ".

## Booster des Basses

Bascule la fonction de basse activée / désactivée	appuyez une fois sur le bouton "  ".
---	---

## Chargez Votre Appareil

L'émetteur FM est équipé de ports de charge rapide QC 3.0 et PD 3.0. Vous pouvez facturer vos appareils via ces ports USB.

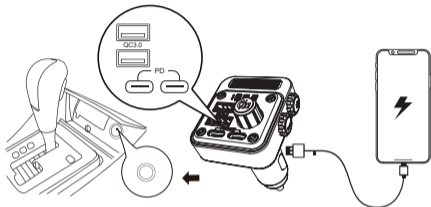

## Avertissement

1. Si la tension de la batterie tombe en dessous de 11 V, l'affichage de tension clignote comme une alarme pour vous rappeler de charger la batterie de la voiture.
2. Évitez de régler le volume de radio-auto trop élevé (généralement 18 ou moins) pour éviter l'augmentation du bruit de fond.
3. Bien que ce produit ait une puissance de transmission relativement forte, il est conseillé d'éviter les fréquences avec de forts signaux locaux pour obtenir une meilleure qualité sonore.
4. N'utilisez pas ce produit dans des environnements poussiéreux, humides ou qui ont des températures extrêmement élevées ou basses.

- 5 Évitez de laisser tomber le produit pour éviter les dommages à la surface ou le dysfonctionnement.
- 6 Ne démontez pas le produit sans autorisation appropriée, car cela annulera la garantie.

## Dépannage

### Dysfonctionnement de l'appareil

1. L'alimentation ne répond pas, ou l'affichage ne montre pas:
  - 1) Assurez-vous que l'appareil est correctement connecté au port de allumeur de cigarettes et que le allume-cigare n'est pas de manière significative.
  - 2) Débranchez l'appareil et essayez à nouveau de le connecter.
  - 3) Vérifiez si le port allume-allume de cigarette reçoit de l'énergie normalement.
2. Impossible de jouer:
  - 1) Assurez-vous que le périphérique USB est correctement connecté au lecteur. Alternativement, essayez d'utiliser un autre appareil USB.
  - 2) Confirmez que les fichiers du périphérique USB sont pris en charge par le produit.
  - 3) Assurez-vous que le volume n'est pas défini sur 0.

## **Ennuis Solides**

1. Le bruit est présent, mais il n'y a pas de son:

- 1) Confirmez que le lecteur est activé et non en mode pause.
- 2) Vérifiez et réglez les paramètres de volume sur l'autoradio, l'émetteur FM et le périphérique externe connecté au besoin.

2. L'audio automobile ne reçoit pas de son:

- 1) Assurez-vous que l'émetteur FM est activé.
- 2) Vérifiez que la fréquence de transmission du transmetteur FM correspond à la fréquence de réception de la radio de la voiture.

3. Mauvaise qualité de transmission avec bruit:

- 1) Assurez-vous qu'aucune station de signal forte ne diffuse à la fréquence de transmission actuelle.
- 2) Lorsque vous utilisez, définissez votre autoradio sur une fréquence inutilisée entre 87,5–108,0 MHz (pour le Royaume-Uni) ou 88,1–107,9 MHz (pour les États-Unis et le Canada). Ensuite, définissez la fréquence du transmetteur NX16 pour correspondre à celle de l'autoradio.

## Garantie

Le produit est livré avec une garantie sans tracas de 12 mois.

Si vous rencontrez des problèmes, nous sommes là pour vous aider. Si vous vous trouvez incapable de résoudre le problème par vous-même, n'hésitez pas à nous contacter pour obtenir de l'aide.



Visit **[www.nulaxy.com](http://www.nulaxy.com)** for our 24/7 live chat or send an email to **[support@nulaxy.com](mailto:support@nulaxy.com)** for support.

## Diagramma del prodotto

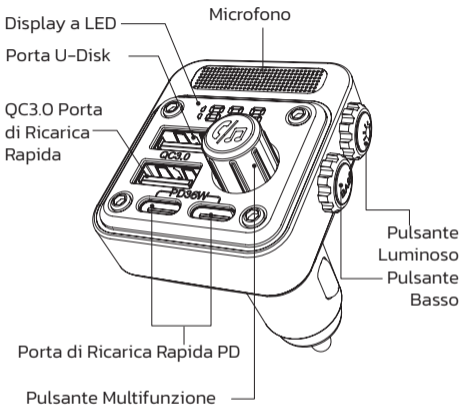

## Contenuto del Pacco

Trasmettitore FM x 1  
 Manuale dell'utente x 1



## Specifiche

Versione Bluetooth	5.3
FM Frequenza	87.0 MHz - 108.0 MHz
Distanza Effettiva Bluetooth	10 metri
QC3.0 Output Della Porta	5V/3A, 9V/2A, 12V/1.5A
PD Output della Porta	5V/3A, 9V/3A, 12V/3A; PPS: 3.3V - 11V/3A
Tensione di Input	12V - 24V
Potenza di Uscita di Maximum	54W
U Capacità del Disco	Max 64 GB

## Installazione

- 1) Inserire il trasmettitore FM nella presa più leggera della sigaretta dell'auto dopo aver avviato il veicolo.

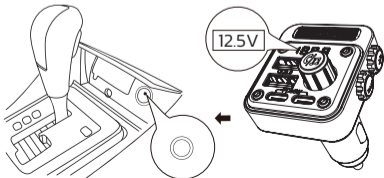

**SUGGERIMENTO:** Assicurati che la presa dell'accendisigari sia pulita e senza ruggine prima di inserire il trasmettitore.

2) All'inserimento, il dispositivo si accenderà automaticamente e il display mostrerà "HI", la tensione di corrente e la frequenza Bluetooth in una sequenza lampeggiante.

## Impostazione della connessione

**Passaggio 1:** abbina il trasmettitore FM con la tua auto

1). Passaggio 1: abbina il trasmettitore FM con la tua auto

**Suggerimento:** cos'è una frequenza inutilizzata?

Una frequenza inutilizzata è un canale senza programmi radio attivi che trasmettono su di esso, producendo solo un leggero fruscio o rumore statico attraverso gli altoparlanti della tua auto.

2). Imposta il trasmettitore FM sulla stessa frequenza della radio automobilistica.

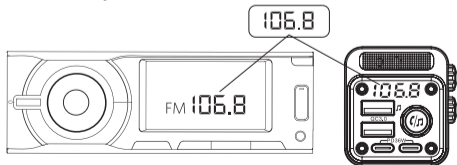

**Passaggio 2:** abbinata il trasmettitore FM con il tuo smartphone

- 1). Abilita Bluetooth sul tuo smartphone, cerca "NX16" e seleziona "Connetti".

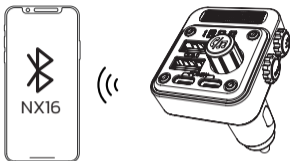

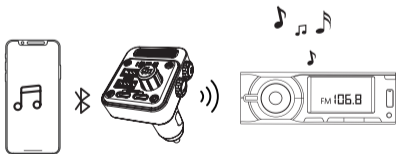

- 2). Una volta connesso correttamente, puoi iniziare a suonare musica, utilizzare la navigazione o goderti le chiamate a mani libere attraverso il dispositivo.





**Nota:** dopo aver inserito un Disk a U nella porta U-Disk, il dispositivo rileverà automaticamente i file musicali in formato MP3, WMA, FLAC, APE o WAV.

## Funzionamento della Funzione



### Regolazione della Frequenza FM

Switch Frequency Regolazione	a lungo premere il pulsante "  " fino a quando la frequenza inizia a lampeggiare.
Aumenta la frequenza	ruotare il pulsante "  " in senso orario.
Ridurre la frequenza	ruotare il pulsante "  " in senso antiorario.



### Regolazione del Volume

Aumenta il volume	ruotare il pulsante "  " in senso orario.
Ridurre il volume	ruotare il pulsante "  " in senso antiorario.
Un tono prompt "gocciolamento, gocciolamento" indicherà che è stato raggiunto il volume massimo.	

### Controllo Musicale

Pausa/riproduzione	premere il pulsante "  " una volta.
Traccia precedente	ruotare rapidamente il pulsante "  " in senso antiorario.
Traccia successiva	ruotare rapidamente il pulsante "  " in senso orario.



## Chiamata a Mani Libere

Rispondi/riattacca una chiamata	premere il pulsante "  " una volta.
Traccia precedente	premi a lungo il pulsante "  ".
Ultima chiamata Refial	premere rapidamente il pulsante "  " due volte.

## Interruttore U-Disk / Bluetooth

Passa tra la modalità U-Disk e Bluetooth	premere rapidamente il pulsante "  " due volte.
--	--

## RGB- Luce Ambientale Arcobaleno

Accendi/spento Modalità luce	premere il pulsante "  " una volta.
Passare attraverso le modalità di illuminazione ambientale	premere il pulsante "  " una volta.
Inserisci la modalità Light Breathing	Premere lungo il pulsante "  ".

## Bass Booster

Attiva/disattiva la funzione dei bassi	premere il pulsante "  " una volta.
--	--

## Carica il tuo Dispositivo

Il trasmettitore FM è dotato di porte di ricarica rapida QC 3.0 e PD 3.0. Puoi caricare i tuoi dispositivi tramite queste porte USB.

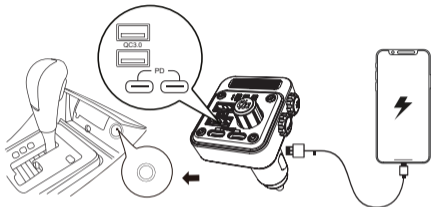

## Precauzioni

- 1 Se la tensione della batteria scende al di sotto di 11 V, il display di tensione lampeggerà come allarme per ricordare di caricare la batteria dell'auto.
- 2 Evitare di impostare il volume della radio auto troppo alta (in genere 18 o inferiore) per evitare un aumento del rumore di fondo.
- 3 Sebbene questo prodotto abbia una potenza di trasmissione relativamente forte, è consigliabile evitare frequenze con segnali locali forti per ottenere una migliore qualità del suono.
- 4 Non utilizzare questo prodotto in ambienti polverosi, umidi o che hanno temperature estremamente alte o basse.

- 5 Evitare di far cadere il prodotto per prevenire danni alla superficie o malfunzionamento.
- 6 Non smontare il prodotto senza un'adeguata autorizzazione, poiché ciò annulla la garanzia.

## **Risoluzione dei problemi**

### **Malfunzionamento del Dispositivo**

1. La potenza non risponde o la visualizzazione non mostra:
  - 1) Assicurarsi che il dispositivo sia correttamente collegato alla porta più leggera di sigaretta e che l'accendino non sia significativamente arrugginito.
  - 2) Scollegare il dispositivo e prova di nuovo.
  - 3) Controllare se la porta più leggera di sigaretta sta ricevendo energia normalmente.
2. Impossibile giocare:
  - 1) Assicurarsi che il dispositivo USB sia correttamente collegato al giocatore. In alternativa, prova a utilizzare un altro dispositivo USB.
  - 2) Conferma che i file sul dispositivo USB sono supportati dal prodotto.
  - 3) Assicurarsi che il volume non sia impostato su 0.

## **Problemi Sonori**

1. Il rumore è presente, ma non c'è suono:

- 1) Conferma che il giocatore è attivato e non in modalità pausa.
- 2) Controllare e regolare le impostazioni del volume sulla radio automobilistica, sul trasmettitore FM e sul dispositivo esterno collegato, se necessario.

2. L'audio dell'auto non sta ricevendo un suono:

- 1) Assicurarsi che il trasmettitore FM sia acceso.
- 2) Verificare che la frequenza di trasmissione del trasmettitore FM corrisponda alla frequenza di ricezione della radio dell'auto.

3. Scarsa qualità della trasmissione con rumore:

- 1) Assicurarsi che non siano trasmesse stazioni di segnale forti alla frequenza di trasmissione corrente.
- 2) Quando è in uso, impostare la radio automobilistica su una frequenza inutilizzata tra 87,5–108,0 MHz (per il Regno Unito) o 88.1–107,9 MHz (per Stati Uniti e Canada). Quindi, impostare la frequenza del trasmettitore NX16 in modo che corrisponda alla radio automobilistica.



## Garanzia

Il prodotto viene fornito con una garanzia senza problemi di 12 mesi.

Se riscontri problemi, siamo qui per aiutarti. Se non ti trovi incapace di risolvere il problema da solo, non esitare a contattarci per assistenza.



Visit **[www.nulaxy.com](http://www.nulaxy.com)** for our 24/7 live chat or send an email to **[support@nulaxy.com](mailto:support@nulaxy.com)** for support.

## Diagrama de productos

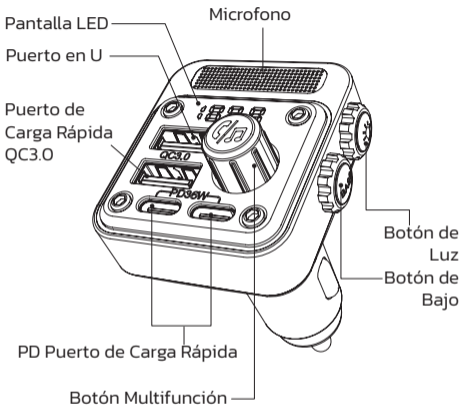

## contenidos del paquete

Transmisor FM x 1  
Manual de Usuario x 1

## Especificaciones

Bluetooth Versión	5.3
FM Frecuencia	87.0 MHz - 108.0 MHz
Distancia efectiva de Bluetooth	10 metros
QC3.0 Salida del Puerto	5V/3A, 9V/2A, 12V/1.5A
Salida del Puerto de PD	5V/3A, 9V/3A, 12V/3A; PPS: 3.3V - 11V/3A
Voltaje de Entrada	12V - 24V
Potencia de Salida de Maximum	54W
U-disco Capacidad	Max 64 GB

## Instalación

- 1) Inserte el transmisor FM en el enchufe del encendedor de cigarrillos del automóvil después de comenzar su vehículo.

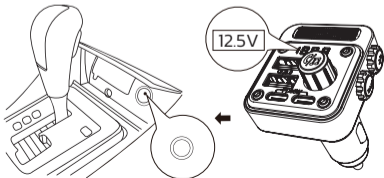

**Consejo:** Asegúrese de que el encendedor del cigarrillo esté limpio y sin óxido antes de insertar el transmisor.

2) Tras la inserción, el dispositivo se encenderá automáticamente, y la pantalla mostrará "HI", el voltaje de corriente y la frecuencia Bluetooth en una secuencia intermitente.

## Ajuste de conexión

**Paso 1:** Empareje el transmisor FM con su automóvil

- 1). Passaggio 1: abbina il trasmettitore FM con la tua auto

**Consejo:** ¿Qué es una frecuencia no utilizada?

Una frecuencia no utilizada es un canal sin programas de radio activos que se transmiten, produciendo solo un ligero susurro o ruido estático a través de los altavoces de su automóvil.

- 2). Establezca el transmisor FM en la misma frecuencia que la radio del automóvil.

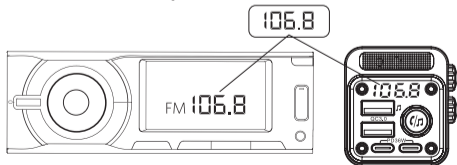

**Paso 2:** Empareje el transmisor FM con su teléfono inteligente

- 1). Habilite Bluetooth en su teléfono inteligente, busque 'NX16' y seleccione 'Conectar'.

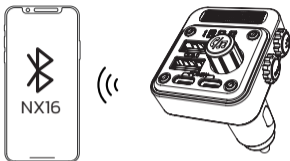

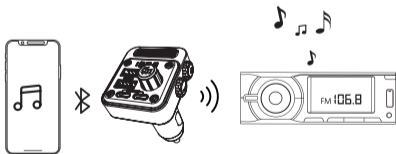

- 2). Una vez conectado con éxito, puede comenzar a reproducir música, usar navegación o disfrutar de llamadas manos libres a través del dispositivo.





**Nota:** Al insertar un disco U en el puerto U-Disk, el dispositivo detectará y reproducirá automáticamente archivos de música en formato MP3, WMA, FLAC, APE o WAV.

## Operación de Función



### Ajuste de Frecuencia FM

Ajuste de frecuencia de interruptor	presione por mucho tiempo el botón "  " hasta que la frecuencia comience a parpadear.
Aumento de la frecuencia	gire el botón "  " en el sentido de las agujas del reloj.
Disminución de la frecuencia	gire el botón "  " en sentido antihorario.



### Ajuste de Volumen

Aumento del volumen	gire el botón "  " en el sentido de las agujas del reloj.
Disminución del volumen	gire el botón "  " en sentido antihorario.
Un tono de inmediato "goteo, goteo" indicará que se ha alcanzado el volumen máximo.	

### Control Musical

Pausa/Play	premere il pulsante "  " una volta.
Pista anterior	gire rápidamente el botón "  " en sentido antihorario.
Siguiente pista	gire rápidamente el botón "  " en sentido horario.



## Llamadas para las Manos Libres

Respuesta/cuelga una llamada	presione el botón "  " una vez.
Rechazar una llamada	Long Presione el botón "  ".
Última llamada redial	presione rápidamente el botón "  " dos veces.

## Switch U-Disk / Bluetooth

Cambie entre el modo U y Bluetooth	presione rápidamente el botón "  " dos veces.
------------------------------------	--

## RGB- Luz ambiental del arco iris

ENCENDER/OFF MODO DE LA LUZ	presione el botón "  " una vez.
Ciclo a través de modos de iluminación ambiental	presione el botón "  " una vez.
Ingrese el modo de luz de respiración	presione largo el botón "  ".

## Potenciador de Bajo

Activa/apague la función de bajo	presione el botón "  " una vez.
----------------------------------	--

## Cargue su Dispositivo

El transmisor FM está equipado con puertos de carga rápidos QC 3.0 y PD 3.0. Puede cargar sus dispositivos a través de estos puertos USB.

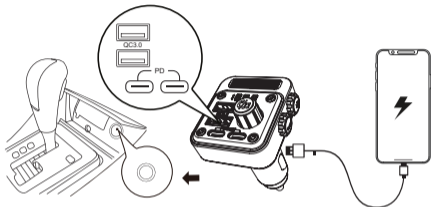

## Advertencia

- 1 Si el voltaje de la batería cae por debajo de 11 V, la pantalla de voltaje parpadeará como una alarma para recordarle que cargue la batería del automóvil.
- 2 Evite establecer el volumen de radio del automóvil demasiado alto (típicamente 18 o menos) para evitar un mayor ruido de fondo.
- 3 Aunque este producto tiene una potencia de transmisión relativamente fuerte, es aconsejable evitar frecuencias con señales locales fuertes para lograr una mejor calidad de sonido.
- 4 No use este producto en entornos polvorientos, húmedos o que tengan temperaturas extremadamente altas o bajas.



- 5 Evite dejar caer el producto para evitar daños en la superficie o mal funcionamiento.
- 6 No desmonte el producto sin una autorización adecuada, ya que hacerlo anulará la garantía.

## Solución de problemas

### Mal funcionamiento del Dispositivo

1. El poder no responde, o la pantalla no se muestra:
  - 1) Asegúrese de que el dispositivo esté conectado correctamente al puerto del encendedor de cigarrillos, y que el encendedor del cigarrillo no esté significativamente oxidado.
  - 2) Desenchufe el dispositivo e intente conectarlo nuevamente.
  - 3) Verifique si el puerto del encendedor de cigarrillos recibe energía normalmente.
2. Incapaz de jugar:
  - 1) Asegúrese de que el dispositivo USB esté conectado correctamente al reproductor. Alternativamente, intente usar otro dispositivo USB.
  - 2) Confirme que los archivos en el dispositivo USB son compatibles con el producto.
  - 3) Asegúrese de que el volumen no esté configurado en 0.

## **Problemas de Sonido**

1. El ruido está presente, pero no hay sonido:

- 1) Confirme que el reproductor está activado y no en modo de pausa.
- 2) Verifique y ajuste la configuración de volumen en la radio del automóvil, el transmisor FM y el dispositivo externo conectado según sea necesario.

2. El audio del automóvil no recibe sonido:

- 1) Asegúrese de que el transmisor FM esté activado.
- 2) Verifique que la frecuencia de transmisión del transmisor FM coincida con la frecuencia de recepción de la radio del automóvil.

3. Mala calidad de transmisión con ruido:

- 1) Asegúrese de que no se transmitan estaciones de señal fuertes a la frecuencia de transmisión actual.
- 2) Cuando esté en uso, configure la radio de su automóvil en una frecuencia no utilizada entre 87.5–108.0 MHz (para el Reino Unido) o 88.1–107.9MHz (para Estados Unidos y Canadá). Luego, configure la frecuencia del transmisor NX16 para que coincida con la radio del automóvil.

## Garantía

El producto viene con una garantía sin problemas de 12 meses.

Si encuentra algún problema, estamos aquí para ayudar. Si no puede resolver el problema por su cuenta, no dude en contactarnos para obtener ayuda.



Visit **[www.nulaxy.com](http://www.nulaxy.com)** for our 24/7 live chat or send an email to **[support@nulaxy.com](mailto:support@nulaxy.com)** for support.

## **FCC Statement**

---

Any Changes or modifications not expressly approved by the party responsible for compliance could void the user's authority to operate the equipment.

This device complies with part 15 of the FCC Rules.

Operation is subject to the following two conditions:

- (1) This device may not cause harmful interference, and
- (2) this device must accept any interference received, including interference that may cause undesired operation.

## **FCC Radiation Exposure Statement**

---

This equipment complies with FCC radiation exposure limits set forth for an uncontrolled environment. This equipment should be installed and operated with minimum distance 20cm between the radiator & your body.

## **IC STATEMENT**

---

This device contains licence-exempt transmitter(s)/ receiver(s) that comply with Innovation, Science and Economic Development Canada's licence-exempt RSS(s). Operation is subject to the following two conditions:

- (1) This device may not cause interference.
- (2) This device must accept any interference, including interference that may cause undesired operation of the device.

L'émetteur/récepteur exempt de licence contenu dans le présent appareil est conforme aux CNR d'Innovation, Sciences et Développement économique Canada applicable aux appareils radio exempts de licence. L'exploitation est autorisée aux deux conditions suivantes:

- (1) L'appareil ne doit pas produire de brouillage,
- (2) L'appareil doit accepter tout brouillage radioélectrique subi, même si le brouillage est susceptible d'en compromettre le fonctionnement.

## Correct Disposal of This Product

---



(Waste Electrical & Electronic Equipment) This Marking shown on the product or its literature  indicate that it should not be disposed with other household wastes at the end of its working life.

To prevent possible harm to the environment or human health from uncontrolled waste disposal, please separate this from other types of wastes and recycle it responsibly to promote the sustainable reuse of material resources. Household user should contact either the retailer where they purchased this product or their local government office, for details of where and how they can take this item for environmentally safe recycling.

Business users should contact their supplier and check the terms and conditions of the purchase contract. This product should not be mixed with other commercial wastes for disposal.

**FCC ID:2ATZS-BC42**  
**Model: BC91**



<b>EC</b>	<b>REP</b>
-----------	------------

**UAB Qixiang Europe**

Pranciškonų g. 6-46, LT-01133 Vilnius, Lithuania

**Technical Information Center**

Trakehner Str. 7-9, 60487 Frankfurt am Main, Germany

**Email: [qixiang.europe@gmail.com](mailto:qixiang.europe@gmail.com)**

**Phone: +49 6976 895074**

<b>UK</b>	<b>REP</b>
-----------	------------

**CET Product Service Ltd.**

Beacon House Stokenchurch Business Park,

Ibstone Rd, Stokenchurch

High Wycombe HP14 3FE UK

**Email: [info.cetservice@gmail.com](mailto:info.cetservice@gmail.com)**

**Phone: +44 741 932 5266**